

Demontage • Disassembly • Demontaż • Демонтаж

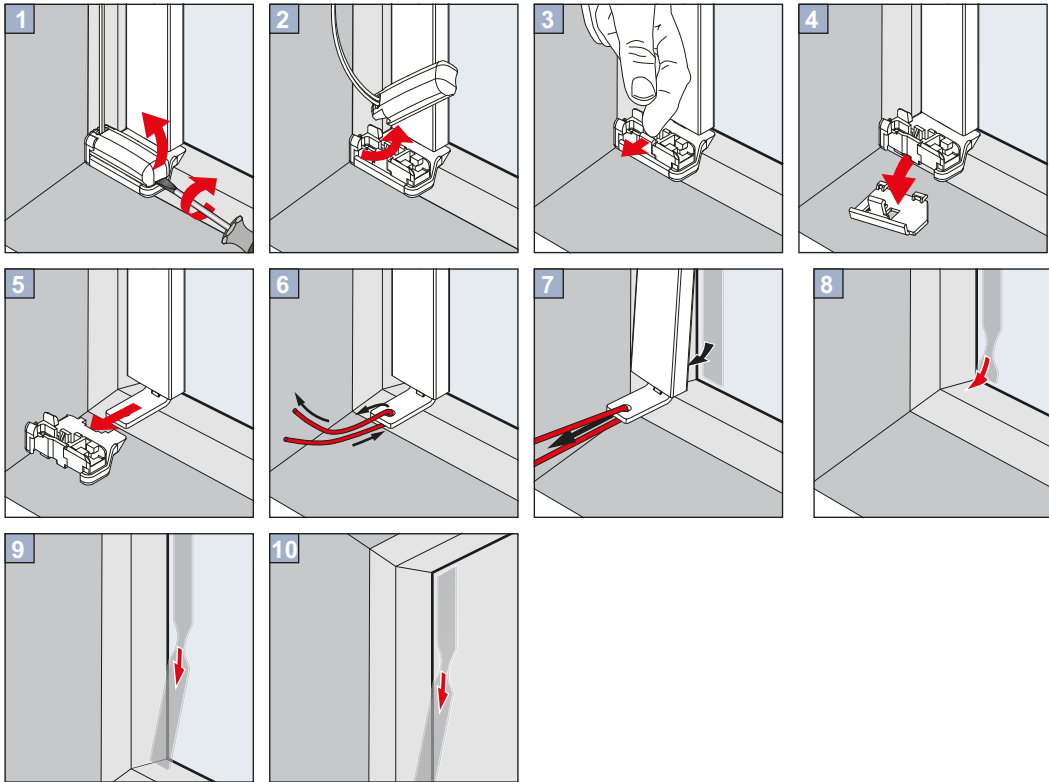

Option • Opcja • Вариант

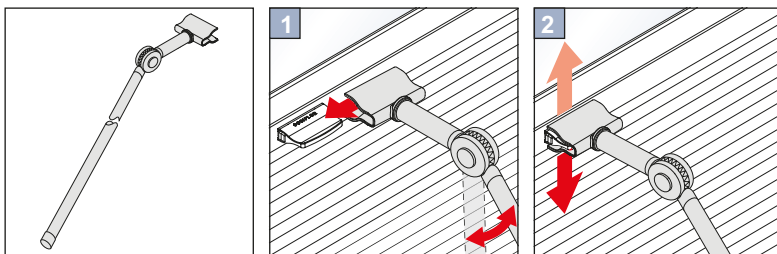

VS 2 KL

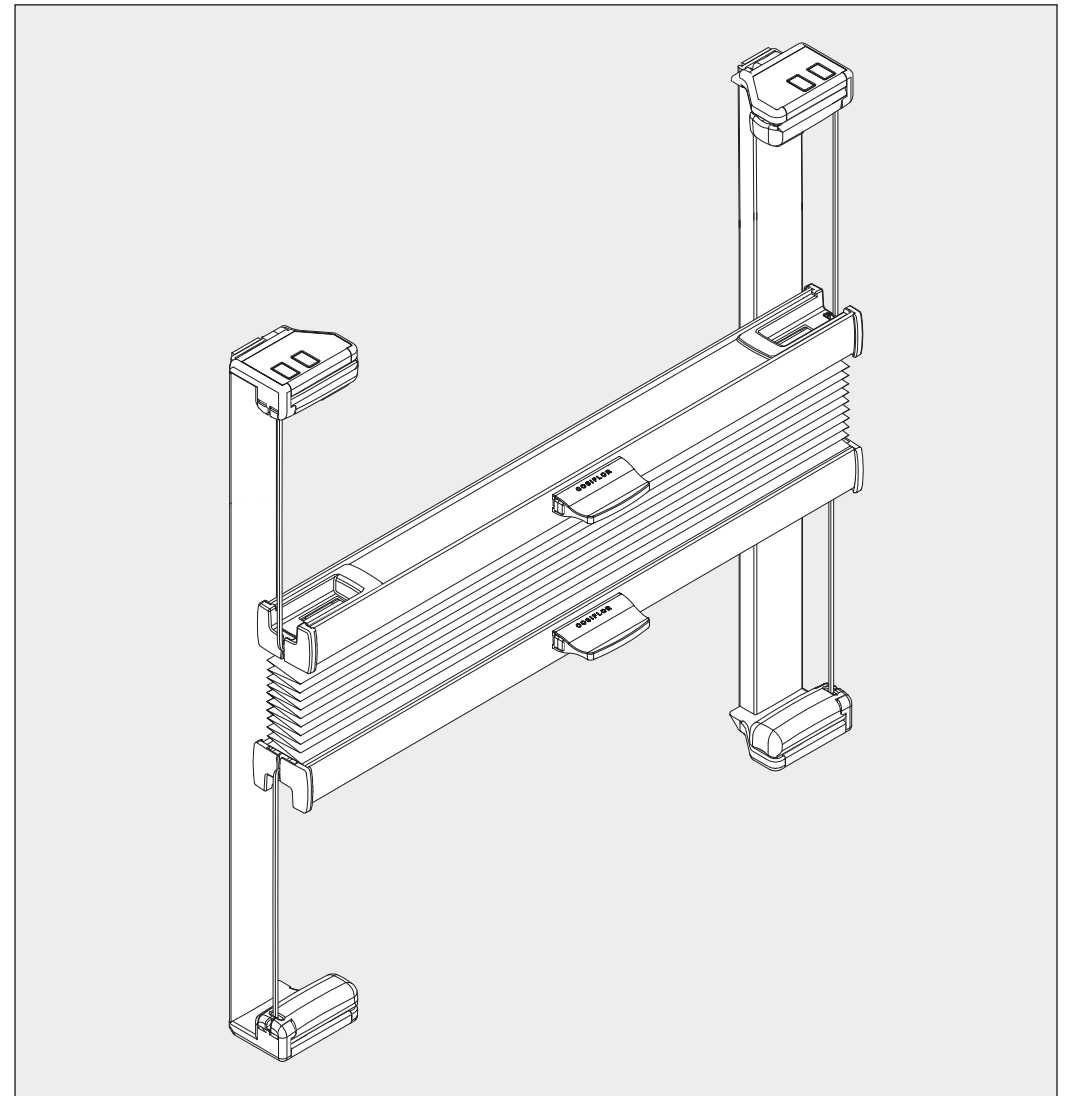
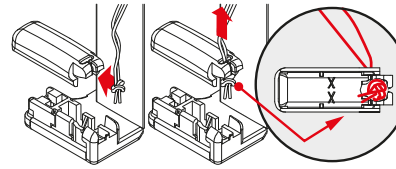

Wichtig! Bitte mit der Pflegeanleitung aufbewahren! - Important! Please keep together with care instructions!  
 Ważne! Proszę przechowywać z instrukcją pielęgnacji! - Внимание! Хранить вместе с инструкцией по эксплуатации!

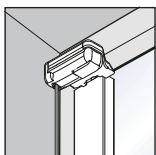

Falzmontage  
Top fixing  
Montaż w świetle szyby  
Монтаж в проем

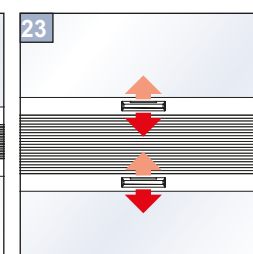
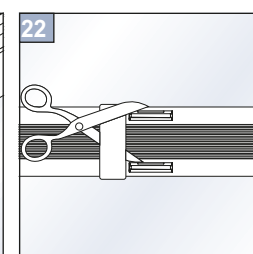
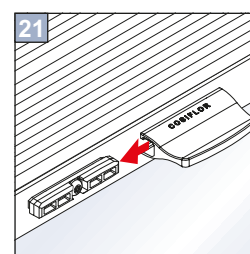
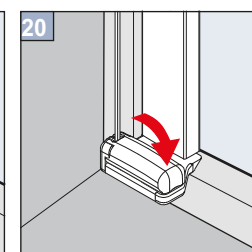
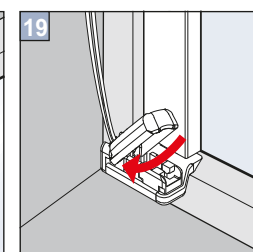
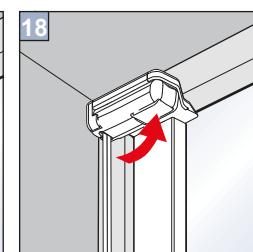
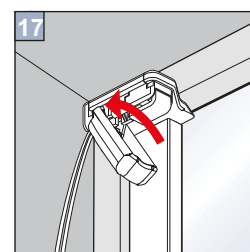
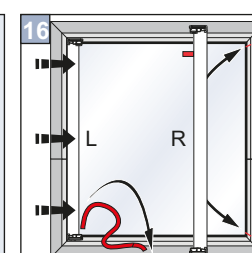
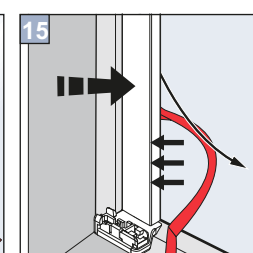
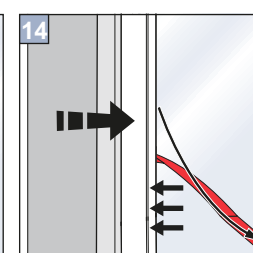
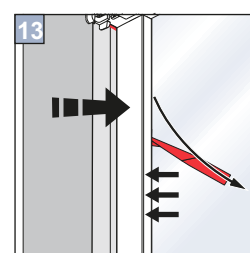
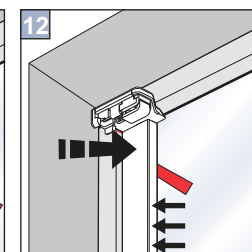
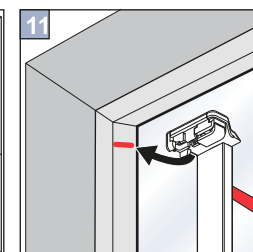
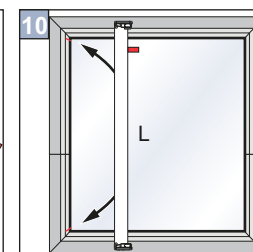
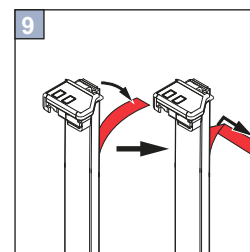
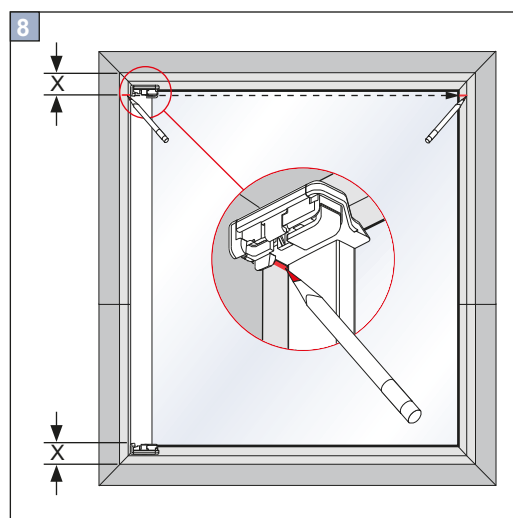
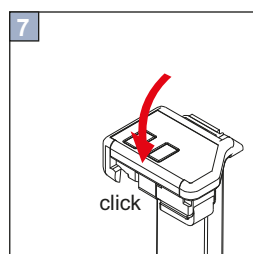
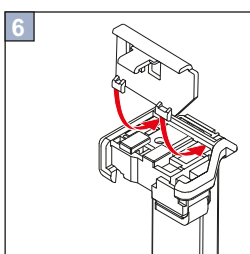
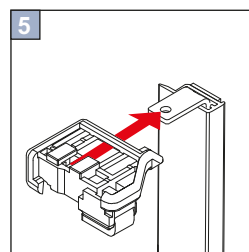
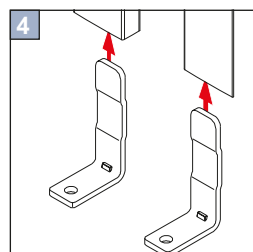
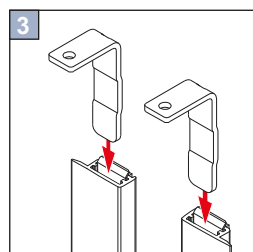
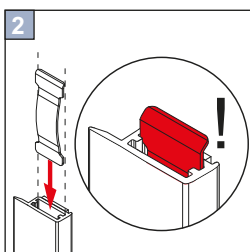
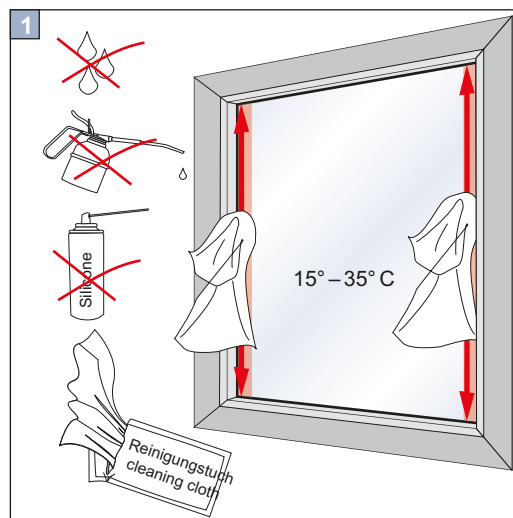
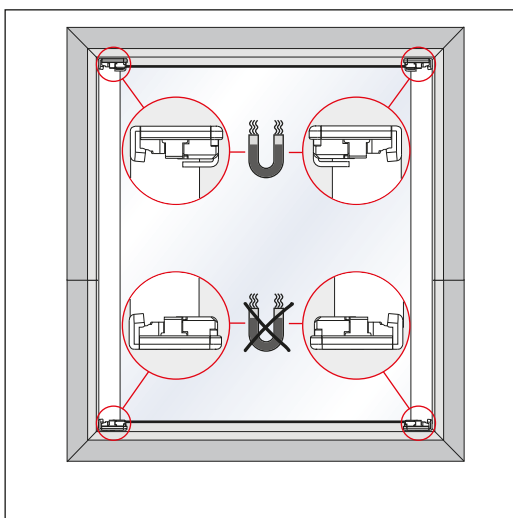

**Wichtig! Important! Ważne! Внимание!**

Luftschlüsse innerhalb der Klebefläche stellen keinen Reklamationsgrund dar, solange die Funktion des Profils nicht beeinträchtigt wird.

Entrapped air within the adhesive area does not constitute a reason for complaint as long as the function of the rail is not affected.

Pęcherze powietrza w obrębie powierzchni klejonej nie stanowią podstawy do reklamacji dopóki nie wpływają one na funkcjonowanie profilu.

Воздушные пузыри на клейкой поверхности не являются основанием для предъявления претензии, если они не влияют на функциональность профиля.