

ffUSS

PLISSEE / Montage- und Pflegeanleitung

PFLGEANLEITUNG

CARE INSTUCTIONS / CONSIGNES DE SOINS / ONDERHOUDSHANDLEIDING / BAKIM TALIMATI

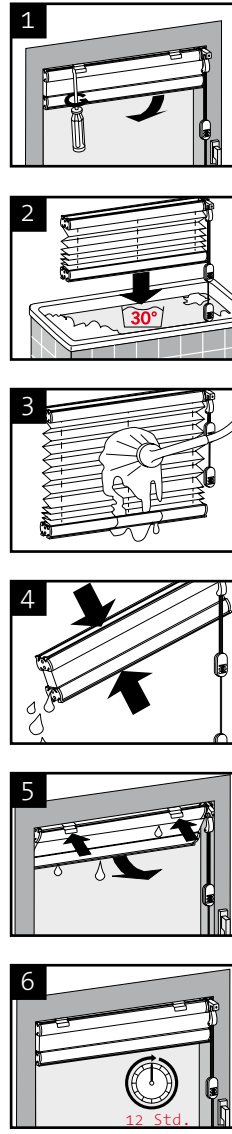

PFLGEANLEITUNG

Die faltenfesten FFUSS-Stoffe sind leicht zu reinigen. Plisseestoffe werden einfach in einer ca. 30°C warmen Feinwaschmittellauge geschwenkt. Gut ausspülen, das Stoffpaket zusammenfalten und Wasser ausdrücken. Die Anlage darf nicht mehr tropfen. Feucht aufhängen und im geschlossenen Zustand trocknen lassen. Während des Trocknens den Faltstore mehrmals öffnen und wieder schließen, damit die Falten nicht verkleben. Nicht bügeln. Bei Elektro- und Kurbelanlagen dürfen die mechanischen Teile nicht in Lauge oder Wasser gelangen. Ausgeschlossen hiervon sind alle metallisierten Stoffe sowie beschichteten Abdunklungsstoffe. Diese sind mit einem Tuch leicht abzuwischen. Nicht reiben! Nähere Angaben bzgl. Reinigungsspezifikationen der einzelnen Stoffe entnehmen Sie bitte der Übersicht „Materialeigenschaften“.

Von einer chemischen bzw. Ultraschallreinigung raten wir ab und übernehmen keinerlei Gewährleistung.

Wichtig:

Für Fensterrahmen und Glas dürfen keine scharfen bzw. alkalischen Reinigungsmittel verwendet werden, die mit der Anlage direkt oder indirekt (Schwitzwasser) in Verbindung kommen. Bei unzureichender Be- und Entlüftung kann es zu Kondenswasserbildung kommen (Bezüglich Montageabstand beachten Sie auch die zugehörige Montageanleitung).

Keine Gewährleistung übernehmen wir für Stoffbeschädigungen, die durch Tropfwasser oder Fliegenexkremente entstehen. FFUSS-Faltstores sind nur für den Einsatz in beheizten Innenräumen geeignet und nicht für den Außenbereich oder Schwimmbäder vorgesehen. Keine Gewährleistung wird deshalb bei einer Montage in offenen oder teilverglasten Überdachungen (Freisitz) sowie Schwimmbädern im Außenbereich, übernommen.

Elektroanlagen sind nicht für die Montage in Feuchträumen (Bäder, Schwimmbäder, Gewächshäuser) geeignet.

Tip:

Bedienen Sie Ihren FFUSS-Faltstore täglich und Sie werden lange Zeit daran Freude haben.

CARE INSTUCTIONS

For Metallised and Black-out materials. For all metallised fabrics as well as coated blackout materials simply wipe down gently with a cloth. Do not rub!

For all other fabrics. The pleated FFUSS fabrics are easy to clean. Simply remove the blind from the window and wash the FFUSS pleated fabrics using a mild detergent solution and water the at approx. 30°C. Rinse thoroughly, fold the fabric parcel together and squeeze the water out by pressing the rails of the blind together until the blind is no longer dripping wet. Hang up damp and leave closed to dry, but open and close the pleated blind several times during the drying process to prevent the pleats sticking together. Do not iron. In the case of electrical and side winder systems, make sure the mechanical/electrical parts do not come into contact with the detergent solution or water. For pretensioned types, tension shoes must not be removed from the cords.

Important:

When cleaning window frames and glass do not use any caustic or alkaline agents which could come into direct or indirect contact (condensation) with the system. Condensation can form if there is too little ventilation or air flow. We do not accept liability for fabric damage caused by water stains or insects. FFUSS pleated blinds are only suitable for use in heated indoor areas and conservatories and have not been designed for outdoor use or swimming pool enclosures. For more details about cleaning specifications for individual fabrics contact your local dealer. We advise against chemical or ultrasonic cleaning and do not accept warranty claims in this case.

Electric systems are not suitable for installation in humid areas.

Tip:

Daily use of your FFUSS pleated blind will keep it in top condition for years satisfaction.

CONSIGNES DE SOINS

Les matériaux anti-plis FFUSS sont faciles à nettoyer. Plonger simplement les stores FFUSS dans un bain tiède à env. 30°C avec du détergent doux. Bien rincer, replier l'ensemble et évacuer toute l'eau. Le dispositif ne doit plus goutter. Accrocher le dispositif encore humide et le laisser sécher en position fermée. Ouvrir et fermer le store plusieurs fois pour éviter un collage de l'ensemble. Ne pas repasser. Les systèmes à entraînement électrique ou à manivelle ainsi que les éléments mécaniques ne doivent pas être mouillés. Toutes les pièces métalliques ainsi que les tissus opaques ne sont exclus. Les nettoyer légèrement à l'aide d'un chiffon. Ne pas froter! Les sabots de serrage sur les installations tendues ne doivent pas être défaits des fixations!

Important:

Pour le nettoyage des cadres de fenêtre et le verre, ne pas utiliser de produit détergent âcre ou alcalin qui puisse entrer en contact direct ou indirect (buée) avec le store. De la condensation peut se former si la ventilation et l'aération de la pièce sont insuffisantes (bien respecter les consignes de montage concernant les distances!). Nous ne pourrions pas être tenus responsables des dommages causés par l'eau ou les excréments de mouche. Les stores FFUSS sont adaptés uniquement à un montage dans des pièces fermées et chauffées et ne conviennent ni à une installation extérieure ni en piscine. Ainsi, nous ne garantissons pas les stores pour un montage en extérieur, sur des toits ouverts ou partiellement vitrés ainsi que dans des piscines. Pour de plus amples informations concernant les consignes de nettoyage de chacun des matériaux, consulter la synthèse des "propriétés des matériaux". Nous déconseillons tout nettoyage chimique ou à ultrason et déclinons toute responsabilité pour des dommages éventuels et décollant.

Les installations à entraînement électrique ne sont pas adaptées aux pièces humides (salle de bains, piscine).

Conseil:

Utiliser les stores FFUSS tous les jours pour en profiter longtemps.

ONDERHOUDSHANDLEIDING

De plooiivaste FFUSS-stoffen zijn gemakkelijk te reinigen. FFUSS-plisseestoffen worden gewoon in een sopje van ca. 30°C met een fijnwasmiddel gespoeld. Goed spoelen, de stof samenvouwen en het water uitdrukken. Het gordijn mag niet meer druppen. Nat ophangen en in gesloten toestand laten drogen. Tijdens het drogen het vouwgordijn meerdere keren openen en weer dichtvouwen zodat de vouwen niet aan elkaar plakken. Niet strijken. Bij elektrische en gemotoriseerde zonwering mogen de mechanische onderdelen niet met water in contact komen. Uitgesloten hiervan zijn alle gemetalliseerde stoffen en verduisteringsstoffen die van een laag voorzien zijn. Die zijn met een doek gemakkelijk schoon te maken. Niet wrijven! De spanschoenen bij VS installaties mogen niet uit de snoeren worden losgemaakt!

Belangrijk:

Voor vensterramen en glas mogen geen agressieve resp. alkalische reinigingsmiddelen gebruikt worden die direct of indirect (condens- met het gordijn in contact komen. Bij onvoldoende ventilatie kan er condens gevormd worden (raadpleeg voor de montageafstand ook de bijbehorende montagehandleiding). Wij zijn niet verantwoordelijk voor beschadiging van de stof door druiwater of excrementen van vliegen. FFUSS-vouwgordijnen zijn uitsluitend voor gebruik in verwarmde binnenruimtes geschikt en niet voor gebruik buiten of in zwembaden. Er wordt dus geen garantie aanvaard bij een montage buiten, bij gedeeltelijke of volledige glazen koepels (patio) en in zwembaden. Meer informatie over de reiniging van de afzonderlijke stoffen vindt u bij het overzicht „Materiaaleigenschappen“. Wij raden een chemische resp. ultrasonere reiniging af en aanvaarden geen enkele garantie.

Elektro-installaties zijn niet voor montage in vochtige ruimtes (badkars, zwembaden, serres) geschikt.

Tip:

Gebruik uw FFUSS-vouwgordijn dagelijks en u zult er jarenlang plezier aan beleven.

BAKIM TALIMATI

Buruşmaz FFUSS kumaşlarının temizliği son derece kolaydır. FFUSS plise kumaşları, yakla 30°C sıcaklıktaki hassas deterjanlı suya daldırılır. Ardından iyice durulanır ve katlanıp bastırılarak suyu sıkılır. Su akıtmayana kadar suyunun süzülmesi gerekmektedir. Daha sonra nemli halde yerine asılır ve kapalı vaziyette kurumaya bırakılır. Katların yapışmaması için kuruma esnasında plise perdeyi bir kaç kez açınız ve tekrar kapatınız. Ütülemeyiniz! Elektro veya kollu tertibatlarda mekanik kısımlar, deterjanlı su veya saf suyla temas etmemelidir. Pencere pervazları ya da camlarında tertibat ile doğrudan ya dolaylı (kondanse su) temas edecek keskin veya alkalik temizlik maddeleri kullanılmalıdır. Tüm metal karışım kumaşlar ile kaplamalı karartma kumaşları bundan hariçtir. Bunlar bezle kolayca temizlenebilirler. Ovmayınız! VS tesislerindeki gerdirme tertibatları sicimlerinden ayrılmalıdır!

Önemli:

Pensere pervazları ya da camlarında tertibat ile doğrudan ya dolaylı (kondanse su) temas edecek keskin veya alkalik temizlik maddeleri kullanılmalıdır. Yetersiz havalandırma nedeniyle kondanse su oluşabilir (montaj sırasında bırakılması gereken mesafe için ilgili montaj talimatına riayet ediniz). Su damlaması ya da sinek pisliklerinin yol açtığı kumaş hasarlarından dolayı sorumluluk kabul etmemekteyiz. FFUSS plise perdeleri sadece ısıtılmış iç meknlarda kullanılabilir ve dış mekanlar ya da yüzm havuzları için uygun de ildir. Bu nedenle dış mekanlara, üstü açık ya da yarı camlı mekanlara (küçük teras) ve yüzm havuzlarına monte edilmesi halinde sorumluluk kabul etmemekteyiz. Her kumaşın temizleme özelliklerine ili kin ayrıntılı bilgi için lütfen "Materiyal özellikleri" bölümüne bakınız.

Kimyasal ya da ultrason temizlemeleri tavsiye etmemekte olup, kullanılması halinde kesinlikle sorumluluk üstlenmemekteyiz.

Elektro tertibatlar, nemli mekanlara (banyolar, yüzm havuzları, seralar) mantaj için uygun değildir.

İpucu:

FFUSS plise perdenizi her gün kullanınız. Onu uzun süre seveerek kullanacaksınız.

VS2, VS3

Bitte diese Montage- und Pflegeanleitung gut aufbewahren!

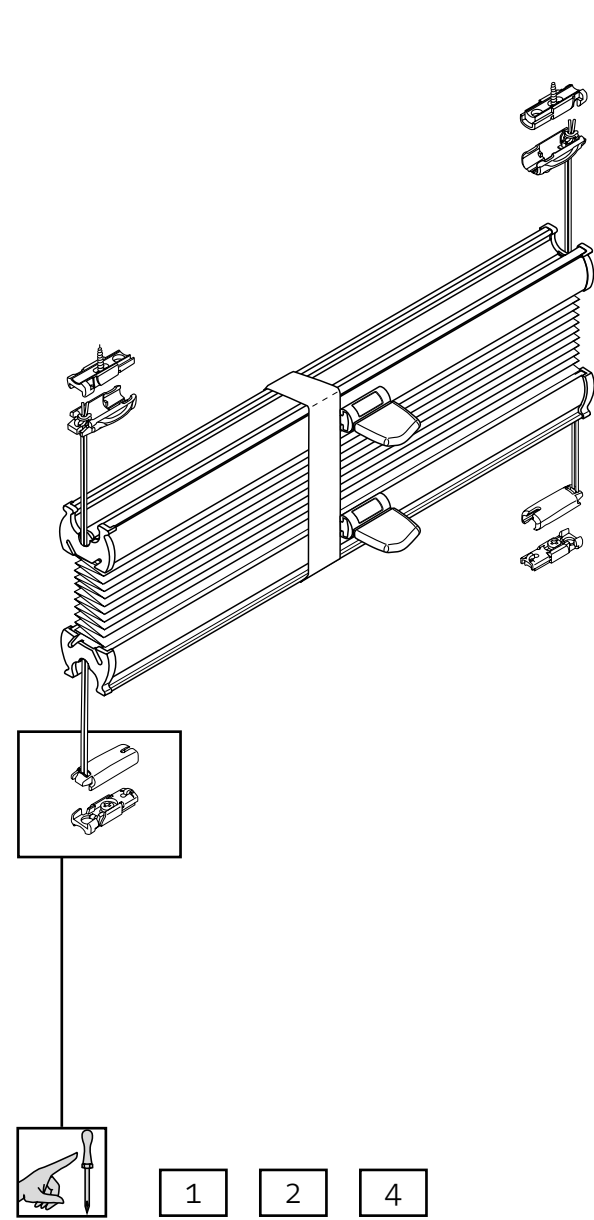

VS1

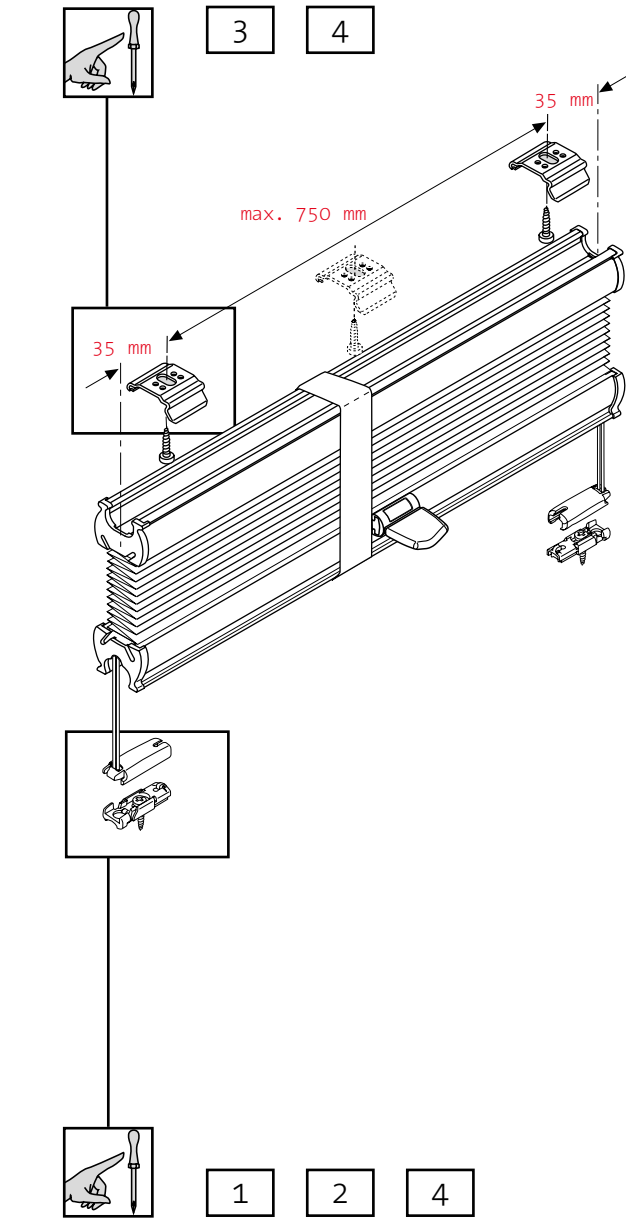

VS2 A

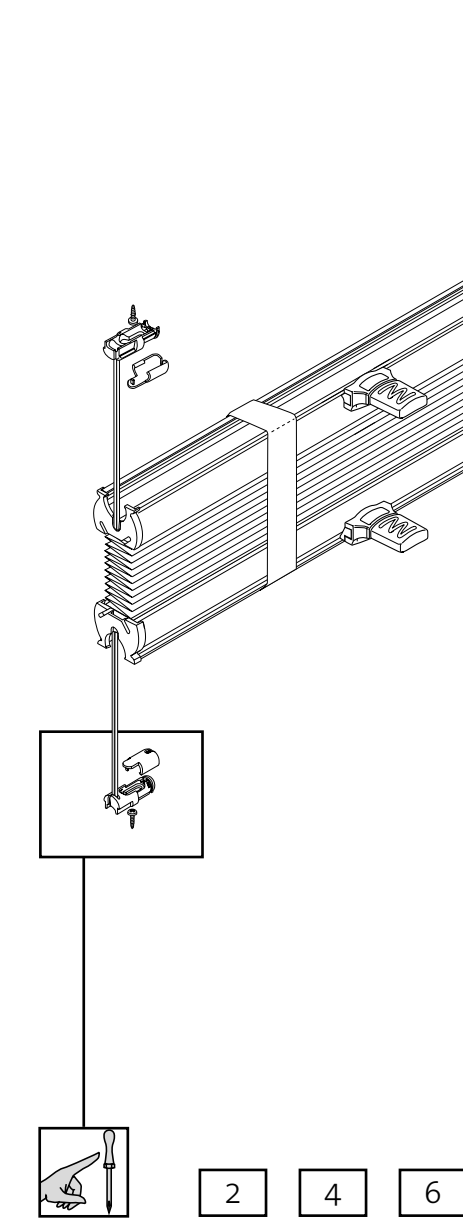

F1, F3

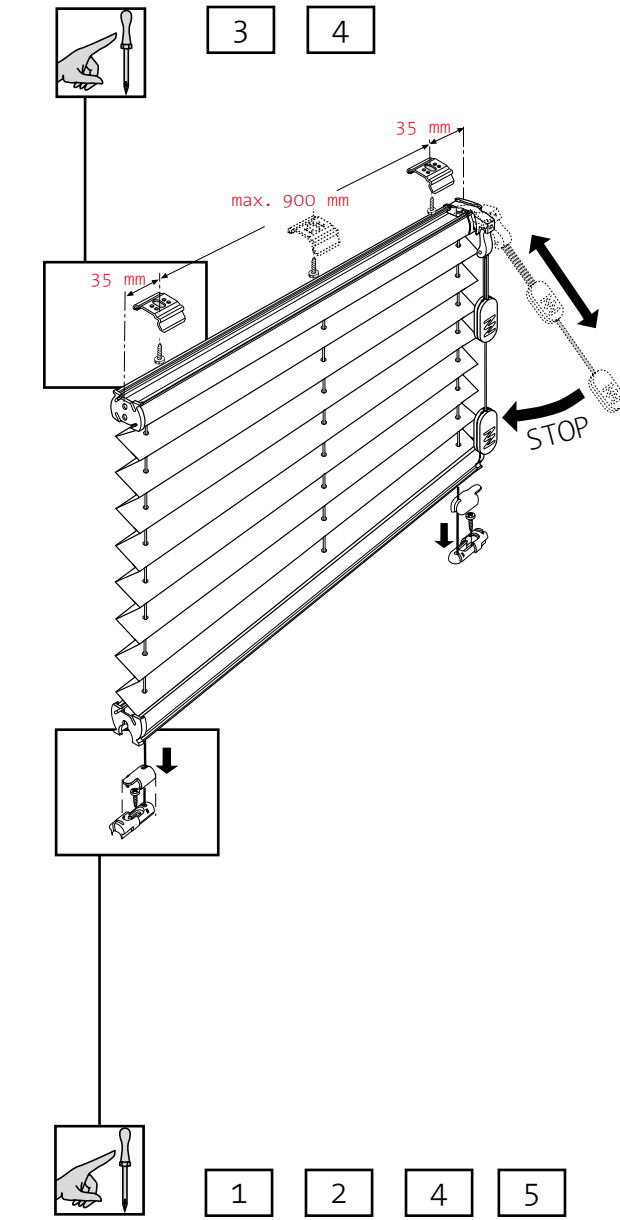

F4, FE

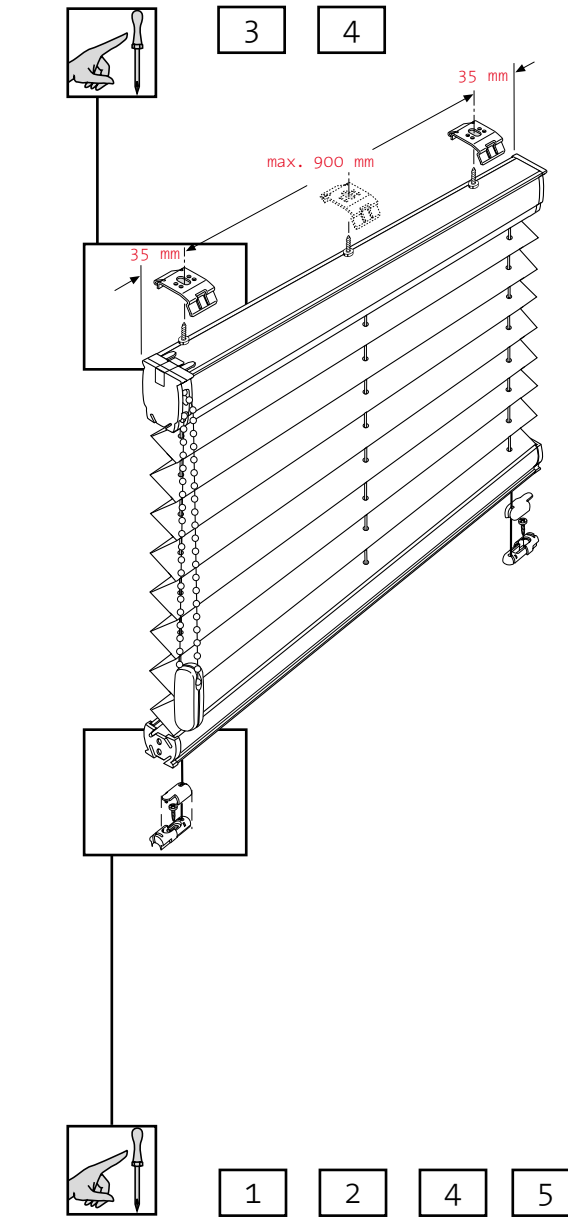

DF 10, DF 30

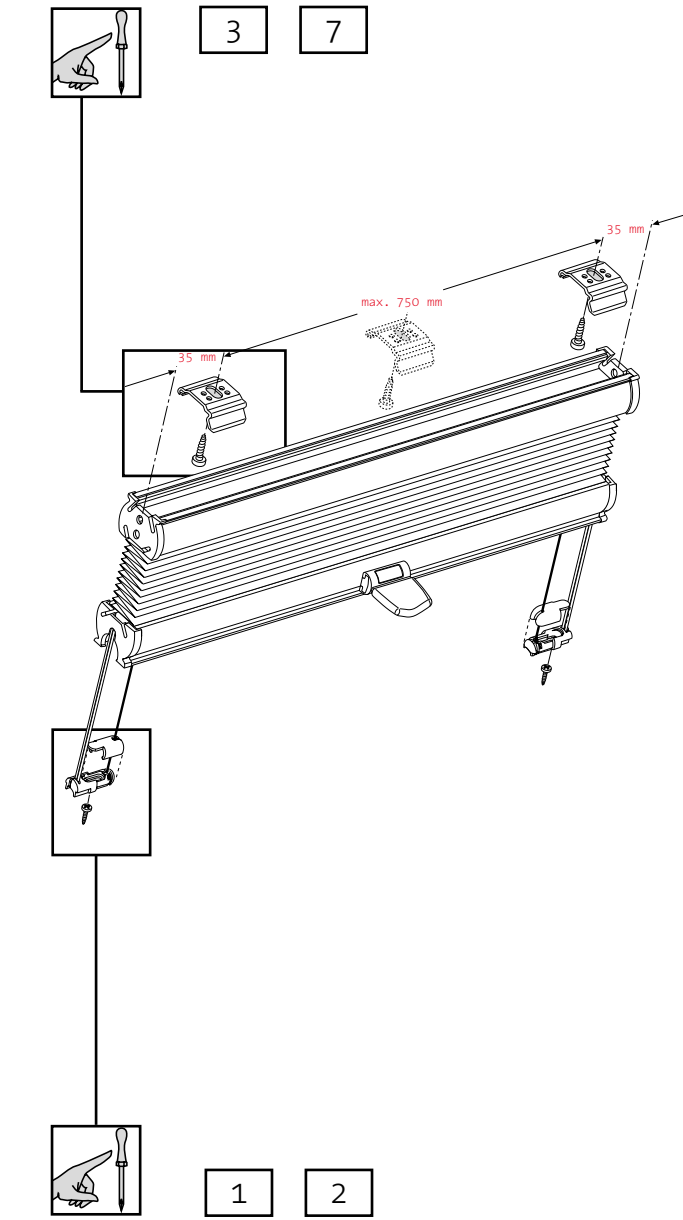

MONTAGE / FITTING / MONTAGE

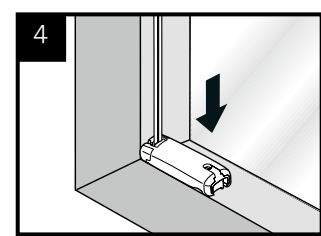
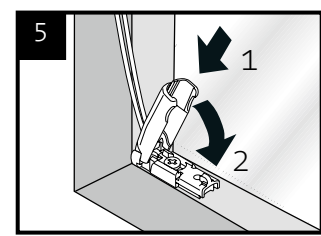
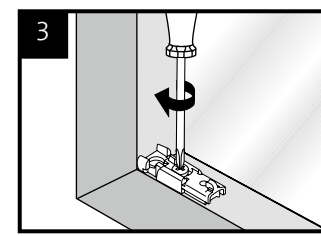
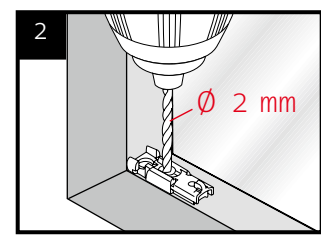
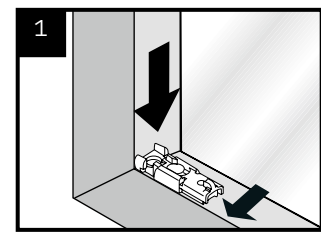
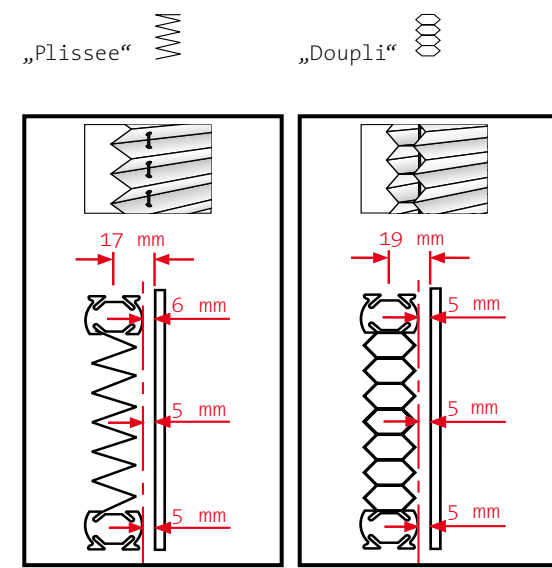

DEMONTAGE / DISSASSEMBLE / DÉMONTAGE

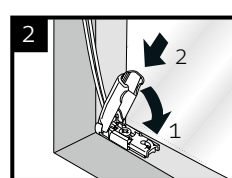
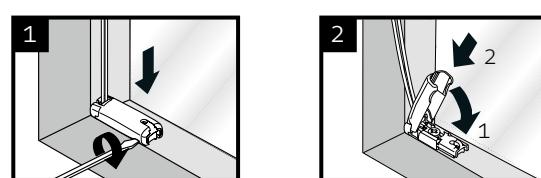

MONTAGE / FITTING / MONTAGE

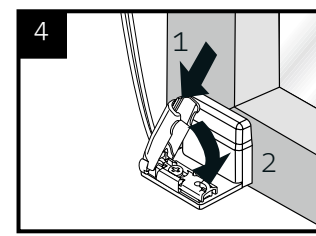
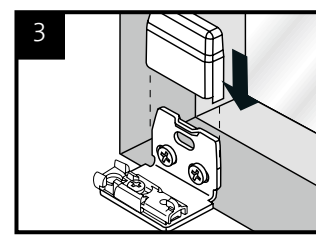
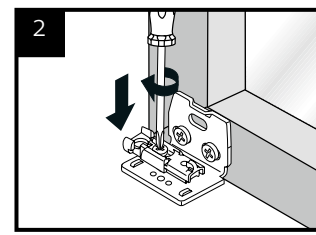
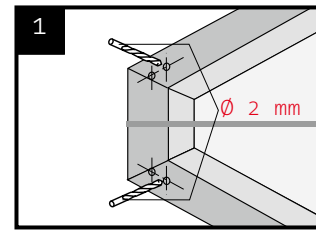
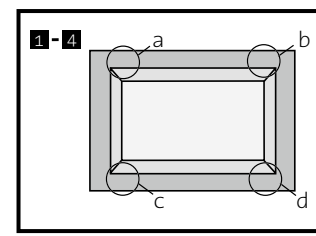

DEMONTAGE / DISSASSEMBLE / DÉMONTAGE

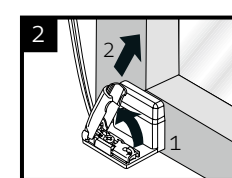
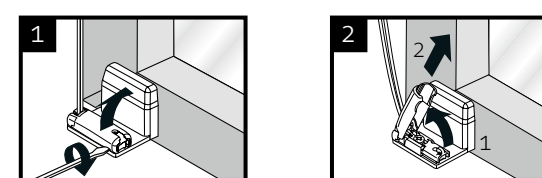

MONTAGE / FITTING / MONTAGE

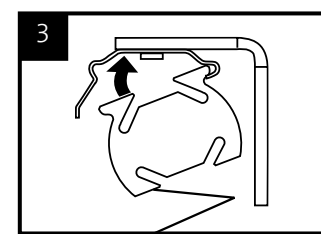
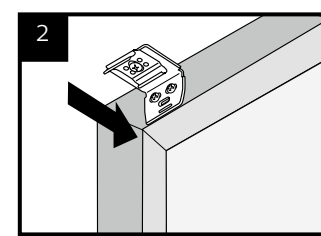
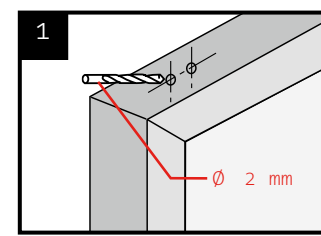
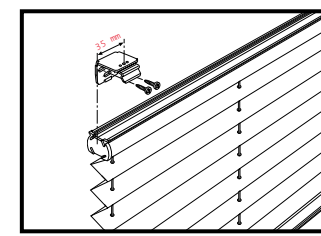
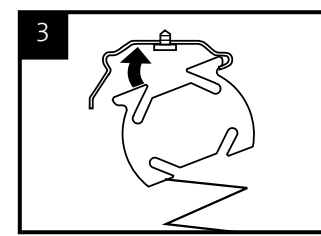
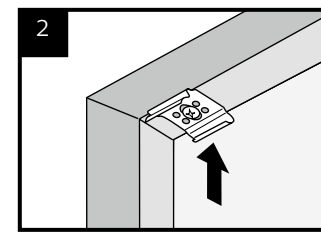
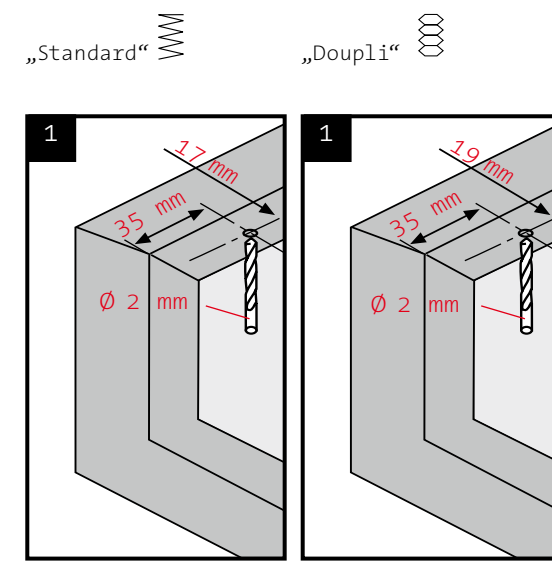

DEMONTAGE / DISSASSEMBLE / DÉMONTAGE

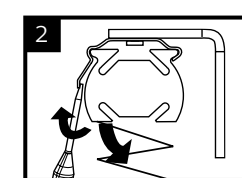
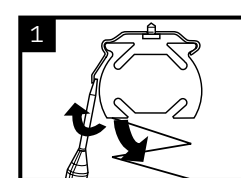

MONTAGE / FITTING / MONTAGE

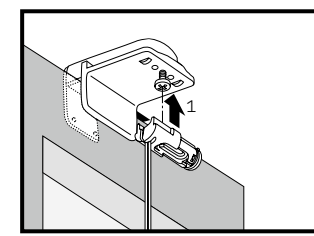
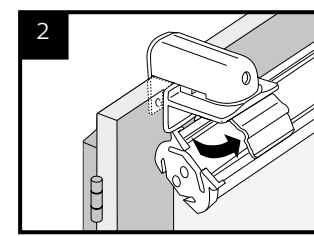
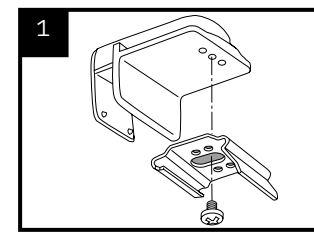
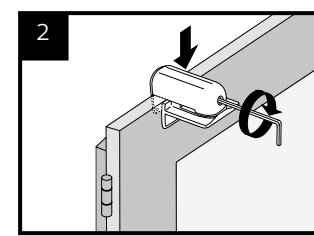
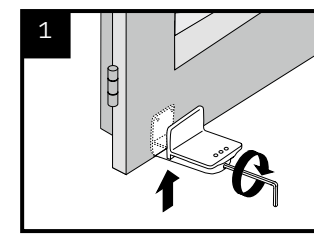

DEMONTAGE / DISSASSEMBLE / DÉMONTAGE

MONTAGE / FITTING / MONTAGE

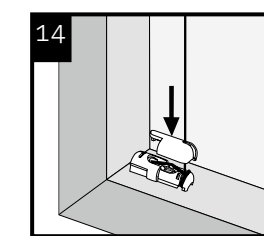
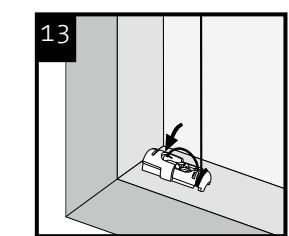
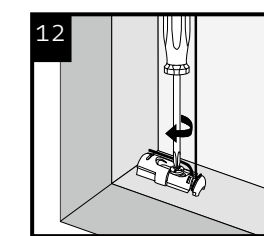
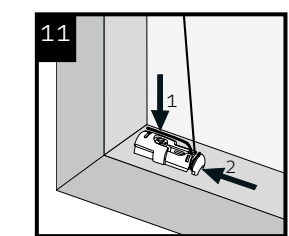
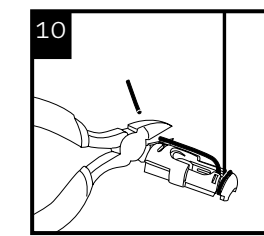
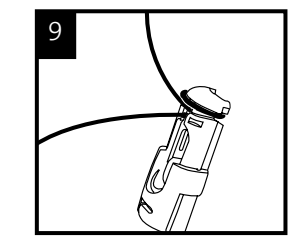
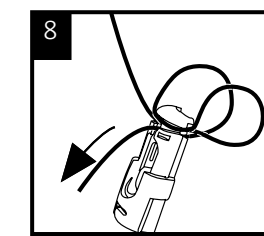
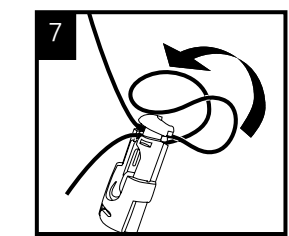
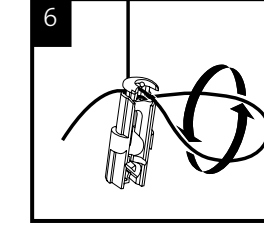
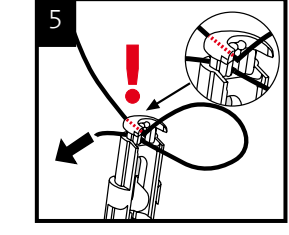
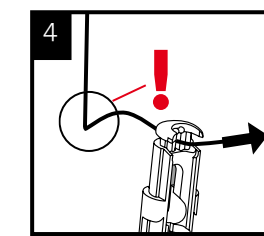
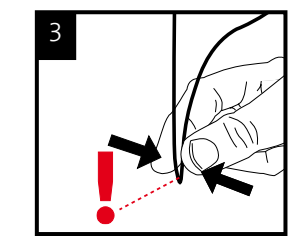
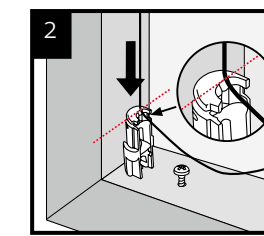
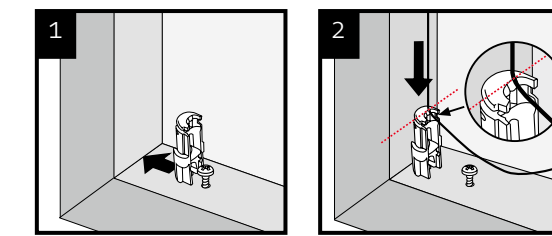

DEMONTAGE / DISSASSEMBLE / DÉMONTAGE

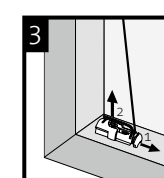
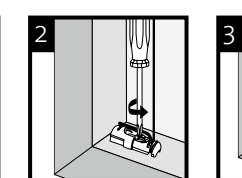
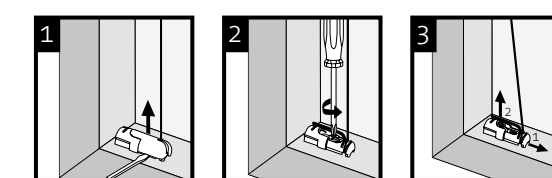

MONTAGE / FITTING / MONTAGE

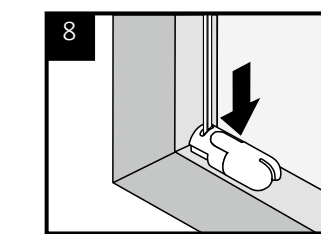
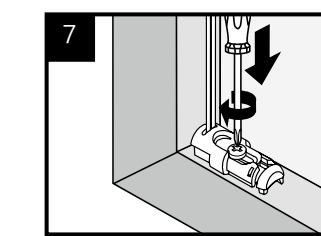
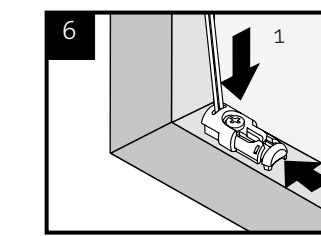
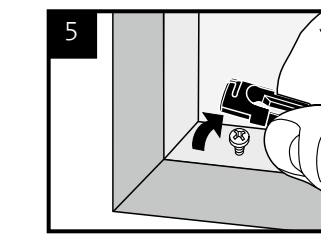
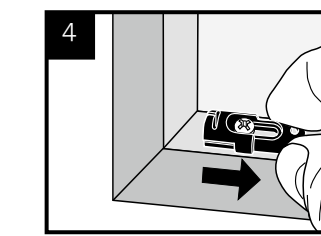
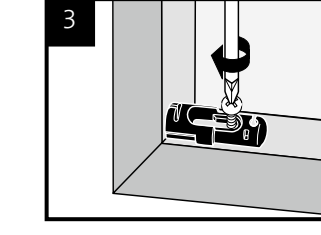
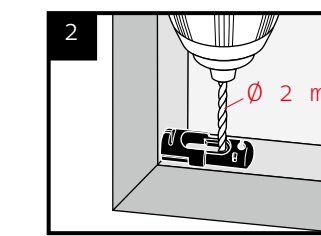
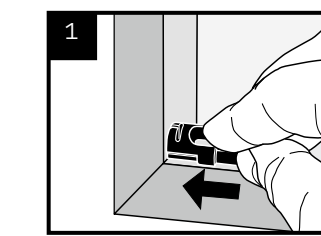

DEMONTAGE / DISSASSEMBLE / DÉMONTAGE

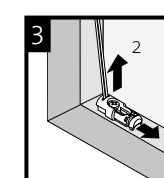
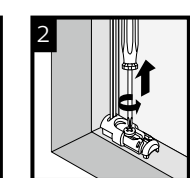
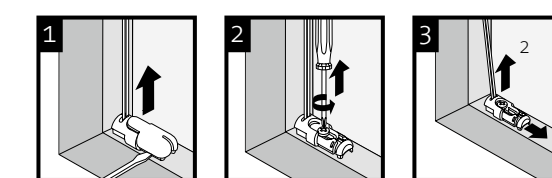

VORBEREITUNG / PREPARATION / PRÉPARATION

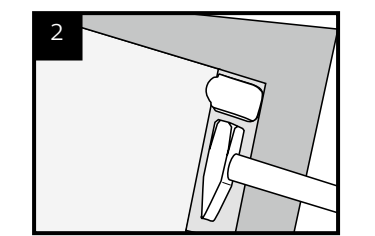
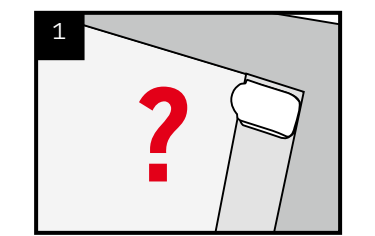

VORBEREITUNG / PREPARATION / PRÉPARATION

